

CADENCE

CVL
EURO SERIES

CVL-88MB

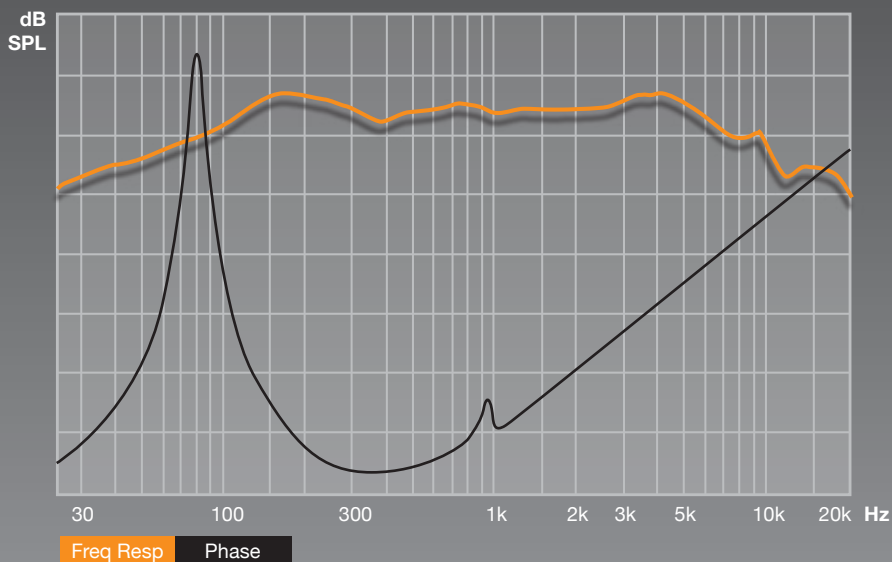

8 in

TS PARAMETERS

REVC: 6 Ohm
FO: 45.625 Hz
SD: 21.350 m M
KRM: 208.003u Ohm
ERM: 1.001
KXM: 18.951m H
EXM: 0.627
VAS: 1.288m Ft

CMS: 5.635 mm/D
MMD: 19.801m Kg
MMS: 21.595g
BL: 9.131 T
QMS: 10.620
QES: 0.446
QTS: 0.428
NO: 0.752%

8 Ohm 300 Watts

SPECIFICATIONS

Application: Mid - Base

Basket Type: Cast Aluminum

Dust Cap: Plastic

Surround Style: Butyl Rubber

Structure Weight: 80 oz.

1.5" High Power Voice Coil

Impedance: 8 Ohm

RMS / Peak Watts: 150 / 300

Frequency Response: 102Hz - 10KHz

SPL @ 1w/1m: 100dB

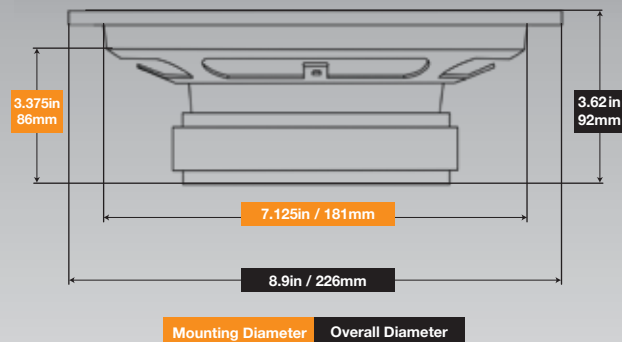

Cadence Acoustics

6519 Highway 9 North • Howell, NJ 07731
800.477.2328 • 732.370.5400 • fax: 732.370.5553 • www.cadencesound.com

