

# CADENCE

**CVL**  
EURO SERIES

**CVLM-68**

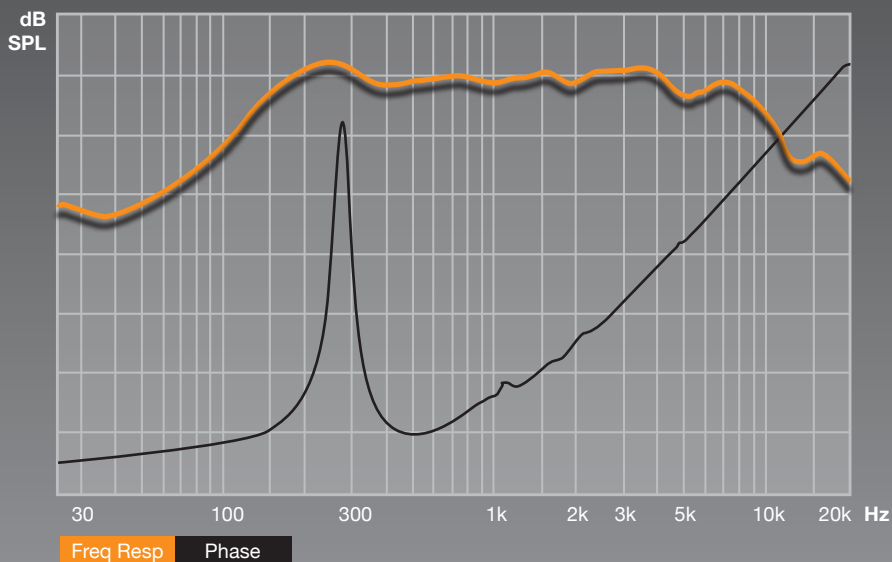

## 6 in



### TS PARAMETERS

<b>REVC:</b> 5.400 Ohm	<b>CMS:</b> 66.747 mm/D
<b>FO:</b> 198.536 Hz	<b>MMD:</b> 8.785m Kg
<b>SD:</b> 12.900 m M	<b>MMS:</b> 9.628g
<b>KRM:</b> 1.222u Ohm	<b>BL:</b> 6.445 T
<b>ERM:</b> 0.834	<b>QMS:</b> 8.116
<b>KXM:</b> 20.696m H	<b>QES:</b> 1.561
<b>EXM:</b> 0.596	<b>QTS:</b> 1.309
<b>VAS:</b> 55.700m Ft	<b>NO:</b> 0.765%

## 8 Ohm 140 Watts

### SPECIFICATIONS

**Application:** Mid - High

**Basket Type:** Open Steel

**Dust Cap:** Bullet

**Surround Style:** Accordion

**Structure Weight:** 40 oz.

**1.5" High Power Voice Coil**

**Impedance:** 8 Ohm

**RMS / Peak Watts:** 70 / 140

**Frequency Response:** 100Hz - 7KHz

**SPL @ 1w/1m:** 98dB

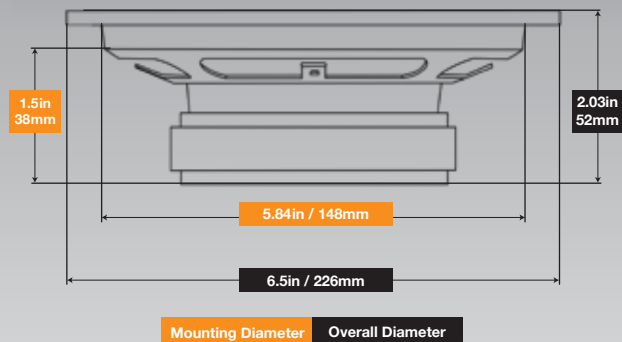

### Cadence Acoustics

6519 Highway 9 North • Howell, NJ 07731  
800.477.2328 • 732.370.5400 • fax: 732.370.5553 • www.cadencesound.com

