

CADENCE

CVL
EURO SERIES

CVLM-68N

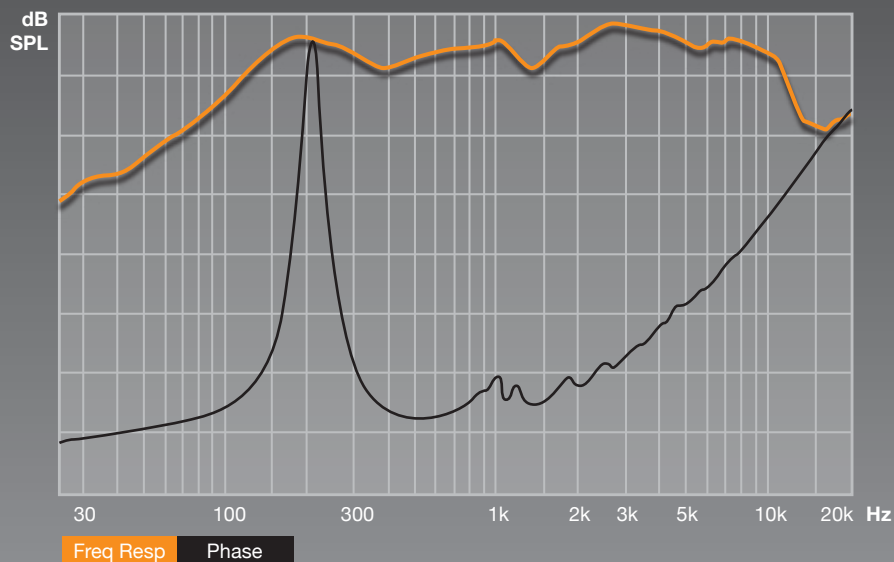

6 in

TS PARAMETERS

REVC: 5.100 Ohm	CMS: 110.958 mm/D
FO: 155.108 Hz	MMD: 8.666m Kg
SD: 12.700 m M	MMS: 9.489g
KRM: 419.548u Ohm	BL: 6.549 T
ERM: 0.871	QMS: 4.939
KXM: 7.865m H	QES: 1.100
EXM: 0.630	QTS: 0.899
VAS: 89.745m Ft	NO: 0.834%

8 Ohm
200 Watts

SPECIFICATIONS

Application: Neo - Mid - High

Basket Type: Graphite Acrylic

Dust Cap: Convex

Surround Style: Accordion

Structure Weight: 20 oz.

1.5" High Power Voice Coil

Impedance: 8 Ohm

RMS / Peak Watts: 100 / 200

Frequency Response: 105Hz - 7KHz

SPL @ 1w/1m: 93dB

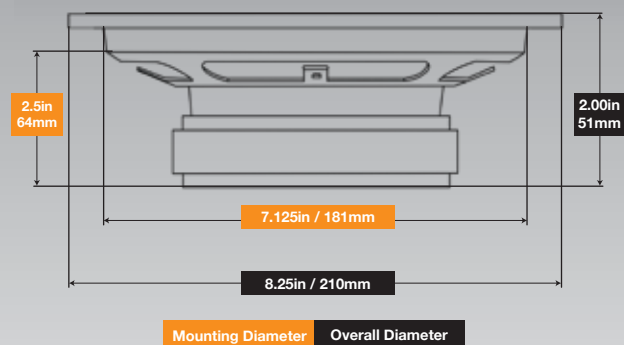

Cadence Acoustics

6519 Highway 9 North • Howell, NJ 07731
800.477.2328 • 732.370.5400 • fax: 732.370.5553 • www.cadencesound.com

