

CADENCE

SUBWOOFERS

Thank you for purchasing this Cadence subwoofer. It was designed and engineered in the United States of America by a team of the most dedicated engineers whose one goal is to provide you, our customer, with the absolute best subwoofer you can buy.

Each subwoofer is painstakingly hand-assembled by a team of experts and then thoroughly tested.

This piece of precision audio equipment is designed to provide you with years of bass performance when installed in the proper enclosure. We strongly recommend that you allow your authorized Cadence dealer to design and build your woofer enclosure so that you maximize your speaker's potential.

BUILDING YOUR OWN ENCLOSURE

On the reverse side of this page are guidelines for the construction of both sealed and vented enclosures. Both types of enclosures will work well with your woofer. The vented enclosure will deliver a louder output, but requires a slightly larger enclosure.

If you decide to build your own enclosure, we strongly recommend that you "measure twice" and "cut once" – that is, always double-check your measurements.

Enclosures should be constructed from MDF or particle board of at least 3/4" thickness. Be sure to glue and screw or staple your enclosure joints tightly – your box must be air-tight to operate properly and efficiently. Use Elmer's brand or similar "carpenters' glue." Internal braces are also recommended.

The Specifications page describes three sizes of enclosure for vented and sealed applications, but many others are possible. Become knowledgeable on the subject and you will be able to design other types of enclosures by plugging in the parameters supplied in this guide. Feel free to call our technical assistance line for custom box designs, or download the free box building software from:

<http://www.linearteam.dk/default.aspx/?pageid=winisd>

Don't forget to leave a donation.

ABOUT THE SPECIFICATIONS

All FS measurements are for NEW woofers. You can expect the FS to drop by at least 5Hz after a few hours of play.

Enclosure measurements INCLUDE woofer and port displacement.

F-3 down points are calculated by computer which models the F-3 in free air response. Typically you can expect the actual 3dB down point to be at least 10Hz lower for actual in-car response.

SPL efficiency measurements listed are done in our labs and are not to be considered an indicator of a woofer's loudness once installed in an enclosure and powered by an amplifier.

Specifications and measurements in this document are subject to change without notice.

Copyright © 2006 Cadence Sound, Inc.

VOICE COIL WIRING DIAGRAMS

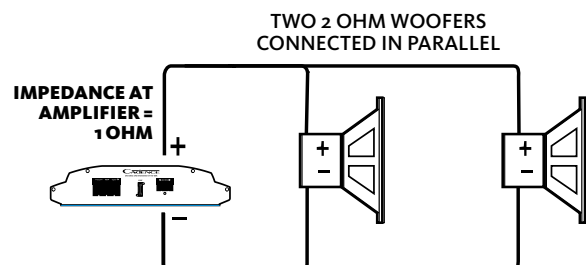
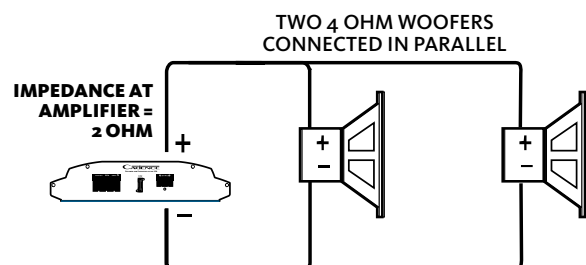
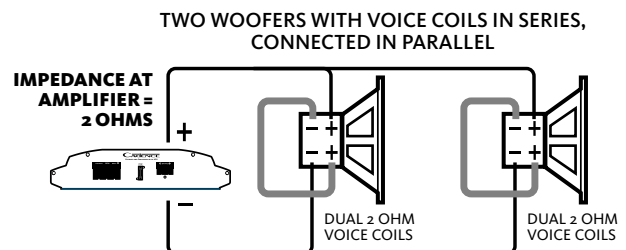
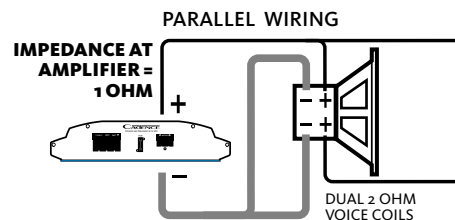
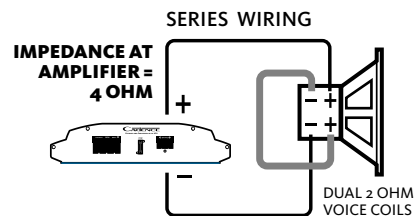

CADENCE

DCX15-1500 SPECIFICATIONS

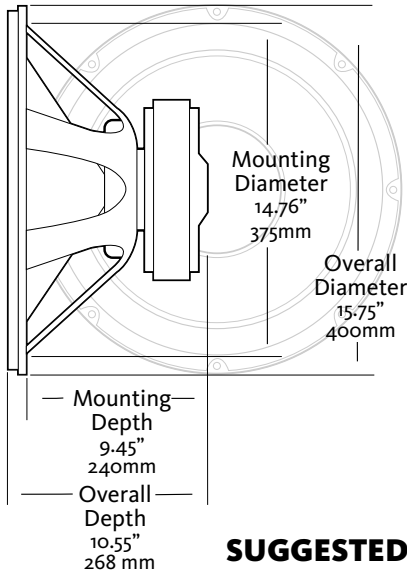

PHYSICAL & INSTALLATION PARAMETERS	
VOICE COIL	3.0" 4-LAYER
WEIGHT	36 LBS. STRUCTURE
CONE	FIBER REINFORCED PAPER
SURROUND	3-LAYER FOAM
SPIDER	LINEAR PROGRESSIVE
DUSTCAP	INJECTION MOLDED
FRAME	CAST ALUMINUM
TERMINALS	8 GAUGE WIRE

PERFORMANCE PARAMETERS	
POWER (WATTS RMS)	1500
POWER (WATTS PEAK)	3000
NOM. IMPEDANCE	4 2
RE (OHMS)	3.2 1.9
FS (HZ)	33.5 32.1
QMS	4.04 4.27
QES	.400 .442
QTS	.364 .401
X-MAX (MM)	10.5 11.5
VAS (CU. FT.)	45.8 51
EFFICIENCY (SPL)	88.9 88.4

All specifications subject to change without notice.

SUGGESTED ENCLOSURE PARAMETERS

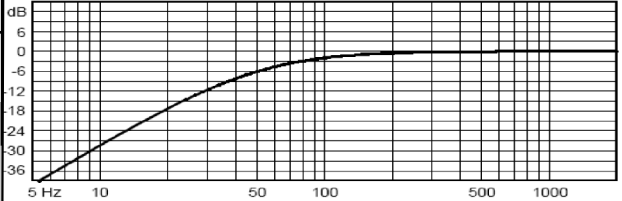
	SEALED ENCLOSURE	SIZE, CUBIC FT (LITERS)	
		2.4 (67)	
	ENCLOSURE DIM. INCHES (MM)	16 x 16 x 16 406 x 406 x 406	
	F-3 (Hz)	62.6	

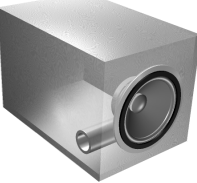
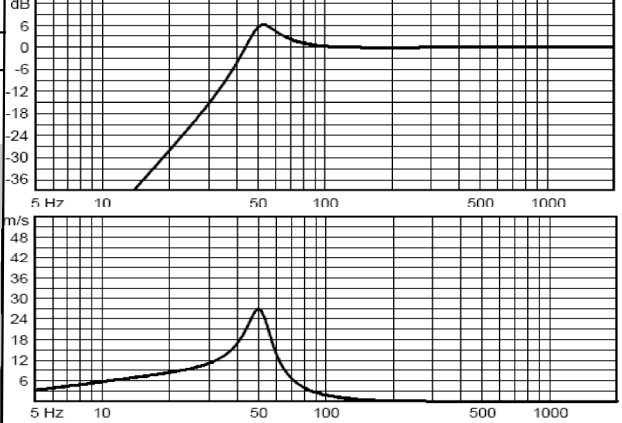
	SPL VENTED ENCLOSURE	SIZE, CUBIC FT (LITERS)	
		2.9 (82.5)	
	ENCLOSURE DIM. INCHES (MM)	18 x 18 x 20 (457 x 457 x 508)	
	SLOT PORT (H X W X L) INCHES (MM)	16.5 x 2.25 x 16.1 (419 x 57 x 409)	
	SYSTEM GAIN (+dB/Hz)	6.08/55.5	
	F-3 (Hz)	40.3	
	TUNING FREQUENCY (Hz)	50	

NOTE: All volumes are based on 3/4" wood.

ENCLOSURE DESIGN NOTES AND CONSIDERATIONS

The enclosure dimensions provided may be adjusted to suit your vehicle layout, but follow our guidelines for enclosure VOLUME. For example, if the suggestions dimensions for an enclosure are 12"W x 16" H x 14" D, multiplying these dimensions together will yield the volume in cubic inches, which can then be divided by 1728 to yield the volume in cubic feet. If your vehicle cannot accommodate the 16" height but a 12" will fit, add the 4" difference to the width or the depth. Check your math to see if the new dimensions multiply out to the same volume.

If the port length recommended is too long to fit into your enclosure, you can bend the port in order to attain the desired length.

The suggested SLOT port sizes are based on the enclosure height, allowing you to add the port by simply reducing the size of the front panel of the enclosure by the width of the port and adding in a single piece of wood top-to-bottom in the enclosure, starting at the front panel and continuing toward the back by recommended slot depth.

For SLOT ports, you can adjust the H and W dimensions as long as the cross-sectional area of the opening remains the same. For example, if the recommended port cross section is 1.5" x 12.2", you can change this to (for example) 3.0" x 6.1" or 4.5" x 3.05". In all these cases, the cross-sectional area of the port is 18.3 square inches.