

CADENCE

XENITH XM 68HC

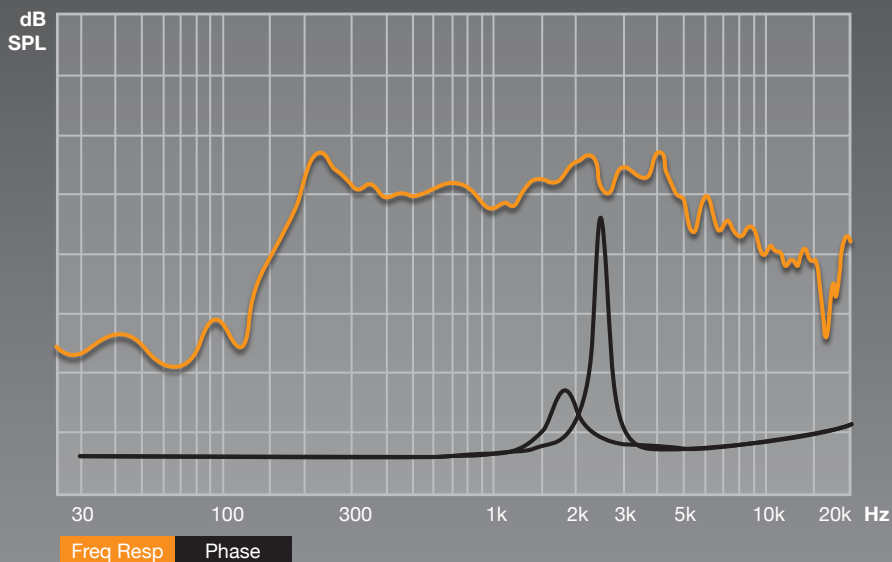

TS PARAMETERS

FMS: 246.0 Hz BL: 6.1
QMS: 9.94 SPL: 102 dB
QES: 2.16 VAS: 1.3 l
QTS: 1.77 RE: 6.8 Ohm
RES: 5.5 Ohm RP: 8.9 Ohm
RMS: 1.2 kg/s LP: 2.1 mH
CMS: 0.05 mm/N CP: 331.4 uF
MMS: 7.7 gr LE: 0.4 mH
NREF: 0.89 %

8 Ohm 150 Watts

SPECIFICATIONS

Application: High Compression

Basket Type: Open Basket

Dust Cap: Bullet

Surround Style: Flat Foam

Structure Weight: 60 oz.

Impedance: 8 Ohm

RMS / Peak Watts: 75 / 150

Frequency Response: 150Hz - 15KHz

SPL @ 1w/1m: 102dB

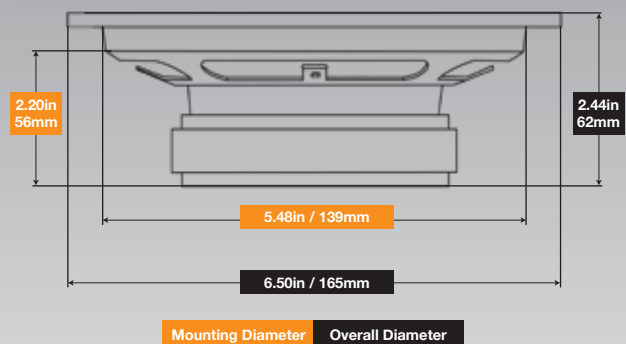

Cadence Acoustics

6519 Highway 9 North • Howell, NJ 07731
800.477.2328 • 732.370.5400 • fax: 732.370.5553 • www.cadencesound.com

